

# Châssis vitré

Pose en extérieur

ATELIER MACOBOIS

32 rue Gambetta - 69170 Tarare  
Tel: 04 74 63 00 19  
www.atelier-macobois.com

## CARACTERISTIQUES

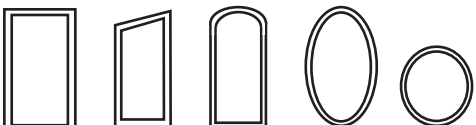
<b>Cadre</b>	Bois lamellé collé LCA Profil droit pour pose en tunnel avec pièce d'appui bois 93 x 70 mm Seuil PMR 20 mm
<b>Profil</b>	Epaisseur 58 mm ou 68 mm par 70 mm Avec doucine intérieur / extérieur
<b>Essence</b>	<ul style="list-style-type: none"><li>▪ Mélèze</li><li>▪ Pin</li><li>▪ Chêne</li><li>▪ BER (bois exotique rouge)</li></ul>
<b>Vitrage</b>	Tous types de vitrages avec performances - Thermique - Coupe-feu / pare-flamme - Acoustique - Feuilleté
<b>Options</b>	<ul style="list-style-type: none"><li>▪ Moulures <i>Voir détail au verso</i></li><li>▪ Petits bois <i>Voir détail au verso</i></li><li>▪ Pièce d'appui bois</li><li>▪ Section élargie</li><li>▪ Aile de rénovation standard (20 mm) ou jusqu'à 40 mm</li><li>▪ Couvre-joint ou cornière d'habillage</li></ul>
<b>Forme du châssis</b>	 Autres : nous consulter



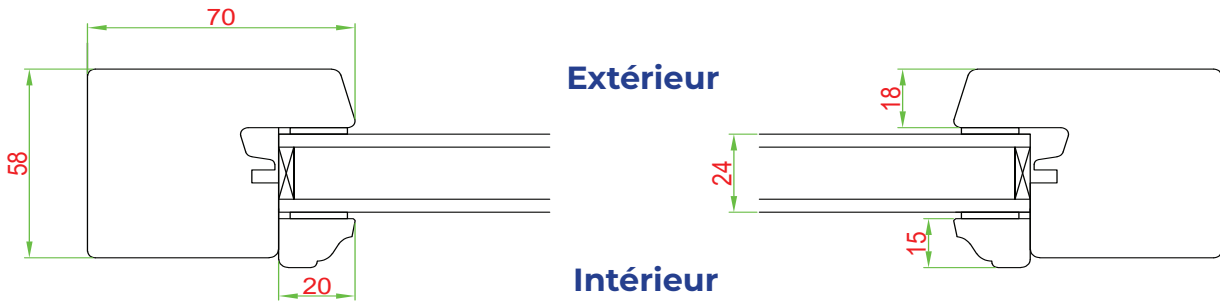

Fabrication française

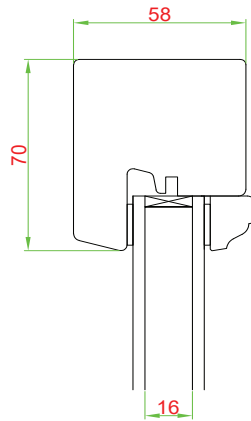

Extrieur

Intérieur

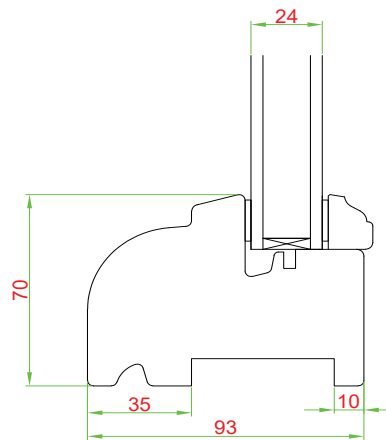

Châssis vitré

Options

Mouleurs

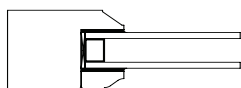

Pente 45° ext  
Doucine int

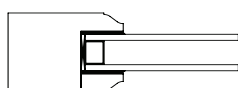

Doucine

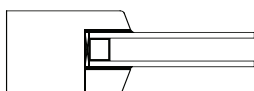

Pente 15°

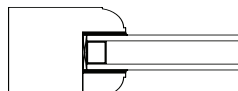

1/4 de rond

Petits bois

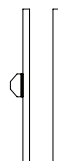

Collés (double face)  
et pointés

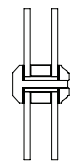

Mortaisés



Collés +  
traverses fictifs

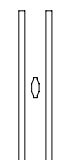

Incorporés